

Olga 300	OP3030 F 28MM	Art. N. (a)	Art. N. (b)	9 m <sup>2</sup>	20,7m <sup>3</sup>	⊗	⊙	⊚	Art. N. (a)	Art. N. (a+b)
		231207	572805			1,12 m	3,45 m	0,64 m	560 kg	631 kg

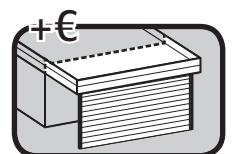

# Olga 300 + PDA30

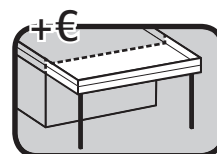
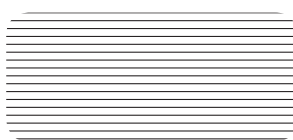
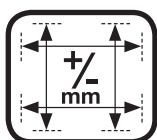
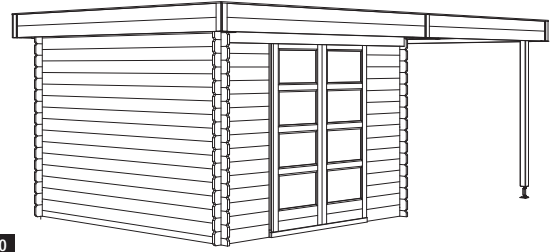
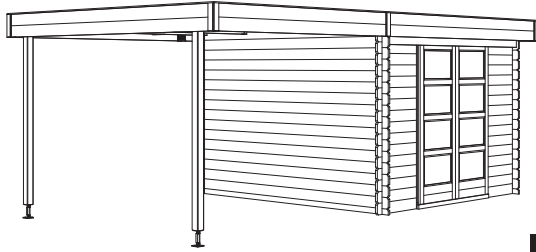

Olga 300 + PDA3030

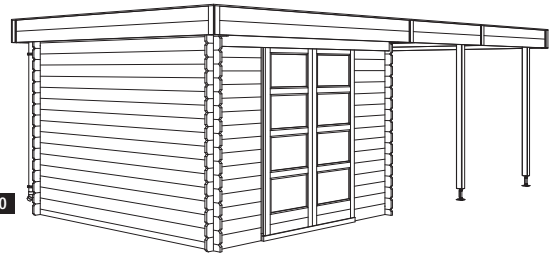
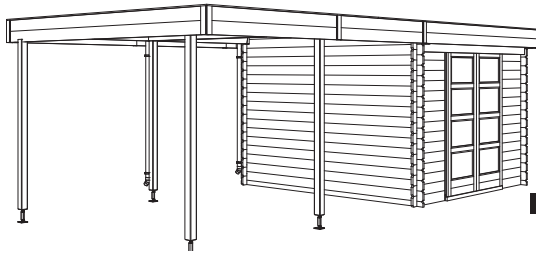

Olga 300 + PDA3040

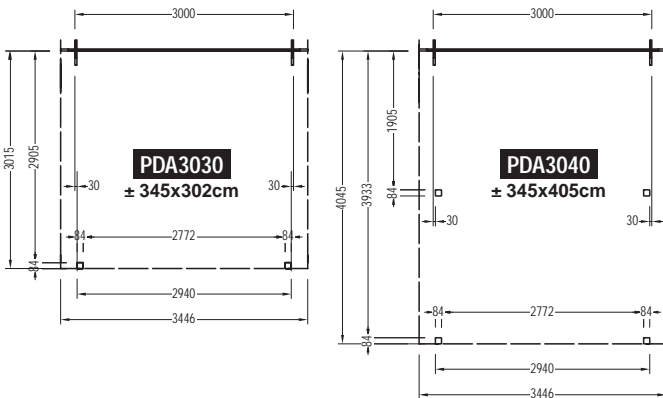

Olga 300	OP3030 F 28MM	Art. N. (a)	Art. N. (b)	9 m <sup>2</sup>	20,7m <sup>3</sup>	⊗	Ⓨ	Ⓩ	Art. N. (a)	Art. N. (b)
+ PDA 3020		457416				1,12 m	3,40 m	0,15 m	665 kg	736 kg
+ PDA 3030		457423				1,12 m	3,40 m	0,20 m	680 kg	751 kg
+ PDA 3040		457546				1,12 m	3,40 m	0,30 m	775 kg	846 kg
+ PDA 3050		457553				1,12 m	3,40 m	0,35 m	790 kg	861 kg
+ PDA 3060		457560				1,12 m	3,40 m	0,40 m	805 kg	876 kg

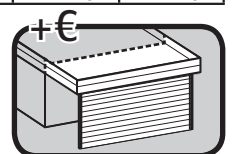
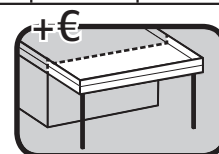
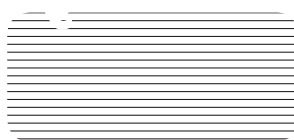
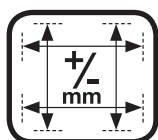

# Olga 300 + PDA30

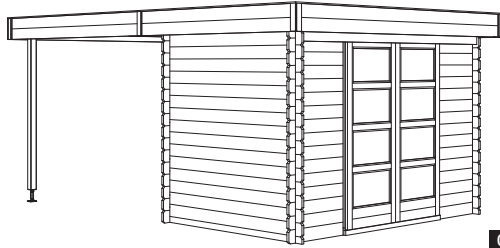

Olga 300 + PDA3030

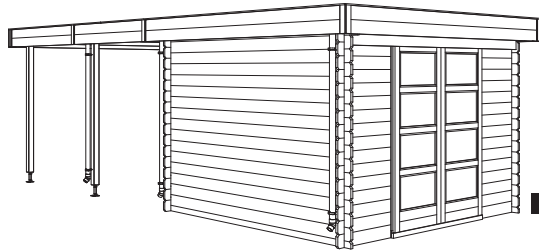
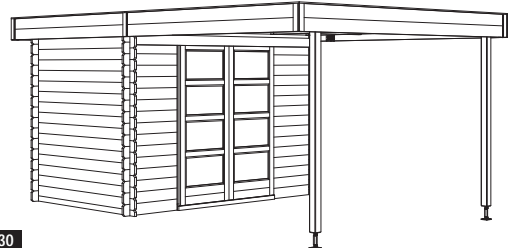

Olga 300 + PDA3040

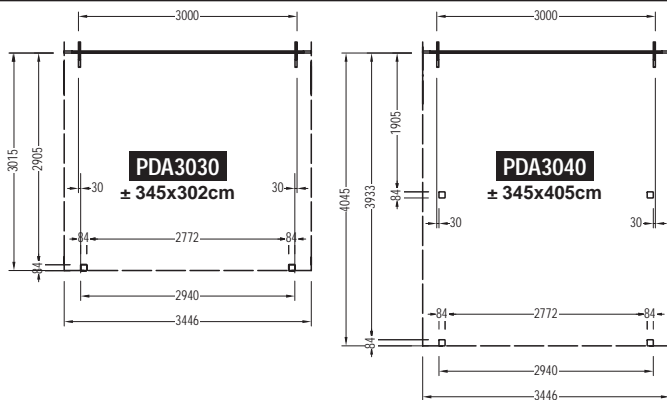
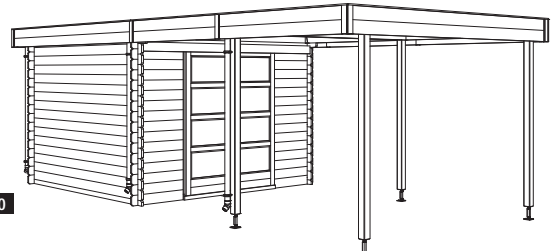

Olga 300	OP3030 F 28MM	231207	572805	9 m <sup>2</sup>	20,7m <sup>3</sup>	⊗	⊙	⊚	Art. N. (a)	Art. N. (a+b)
+										
+	PDA 3030		457423			1,12 m	3,40 m	0,20 m	680 kg	751 kg
+	PDA 3040		457546			1,12 m	3,40 m	0,30 m	775 kg	846 kg
+										
+										

