

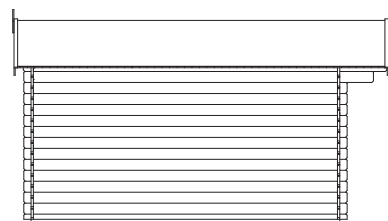

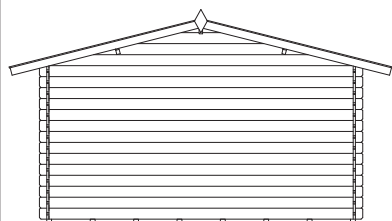

Niels 380

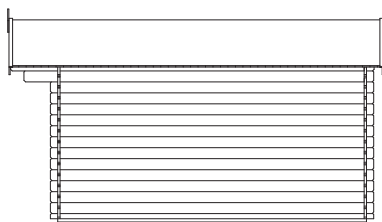
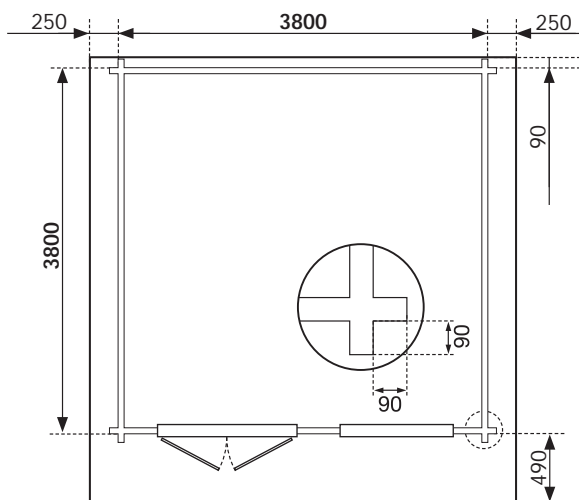
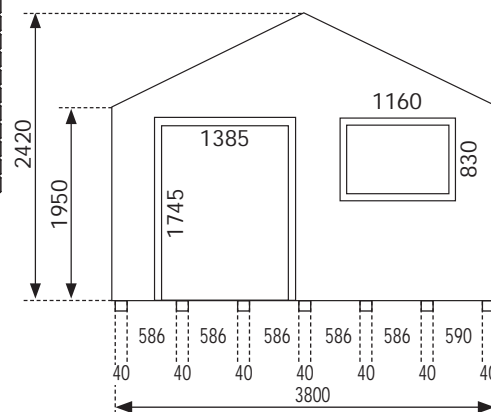
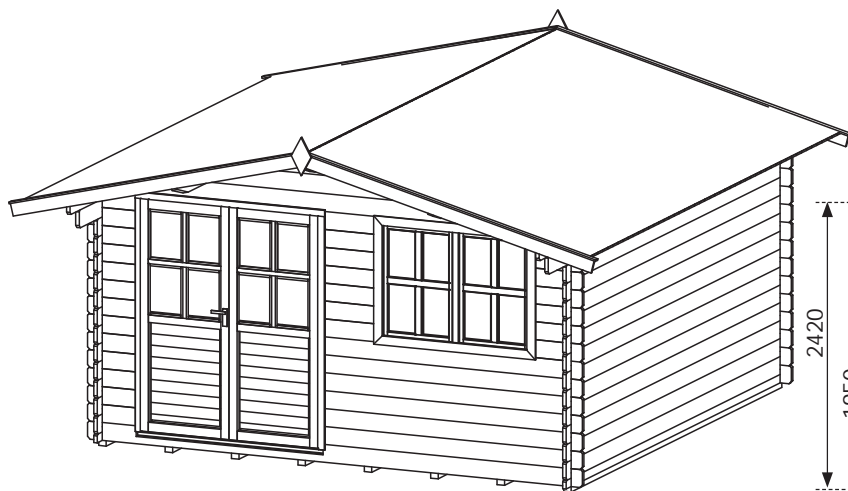
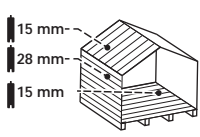
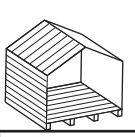
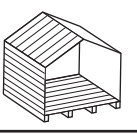

						 30 St/LKW 6x5 							
	Art. Nr.	EAN Nr.	14,4 m ²	32 m ³	18,9 m ²		<table border="1"> <thead> <tr> <th>⊗ mm</th> <th>Ⓨ mm</th> <th>Ⓩ mm</th> <th>kg</th> </tr> </thead> <tbody> <tr> <td>1150</td> <td>4450</td> <td>560</td> <td>849</td> </tr> </tbody> </table>	⊗ mm	Ⓨ mm	Ⓩ mm	kg	1150	4450
⊗ mm	Ⓨ mm	Ⓩ mm	kg										
1150	4450	560	849										
G112513	599553063677												

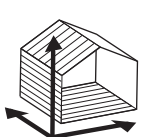
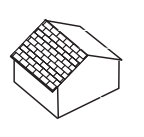
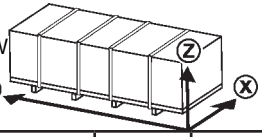